

Xenon-RUBY Lens

Xenon-RUBY 2.3/35

The Xenon-Ruby lens is optimized in accordance with the sensitivity of modern image sensors up to 1 / 1.8" (9mm). This lens is the perfect trade-off between price and performance: By having a practice-oriented speed of 2.3, a very high optical performance is achieved.

Even under production and / or extreme conditions, the robust mechanical design with lockable focus and iris setting mechanism guarantees reliable continuous use in which the set optical parameters remain in place.



Xenon-RUBY 2.3/35

Key Features

- Robust mechanics for rough industrial environment
- Compact design and low weight
- Focus and iris setting lockable
- High resolution optics
- Transmission 400 - 1000 nm (VIS - NIR)
- Designed for Sensors up to 1 / 1.8" (9mm)

Applications

- Traffic
- Security/Surveillance
- Machine vision and other imaging applications
- Quality control
- Surface inspection
- 2D / 3D Measurement

Technical Specifications

F-stop range	2.3 - 16
Focal length	34.84 mm
Image circle	9 mm
Transmission	400 - 1000 nm
Interface	C-Mount
Filter Thread	M25.5 x 0.5
Weight	55 gr.
Code No.	1074627

Contact

Jos. Schneider Optische Werke GmbH
 Ringstraße 132
 55543 Bad Kreuznach
 Germany
 Phone +49 671 601-205
 Fax +49 671 601-286
<http://www.schneiderkreuznach.com/en/industrial-solutions/>
industrie@schneiderkreuznach.com

Schneider Asia Pacific Ltd.
 20/F Central Tower, 28 Queen's Road
 Central, Hong Kong
 China
 Phone +852 8302 0301
 Fax +852 8302 4722
www.schneider-asiapacific.com
info@schneider-asiapacific.com

Schneider Optics Inc.
 285 Oser Ave.
 Hauppauge, NY 11788
 USA
 Phone +1 631 761-5000
 Fax +1 631 761-5090
www.schneideroptics.com/industrial
industrial@schneideroptics.com

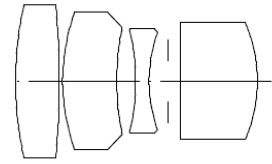
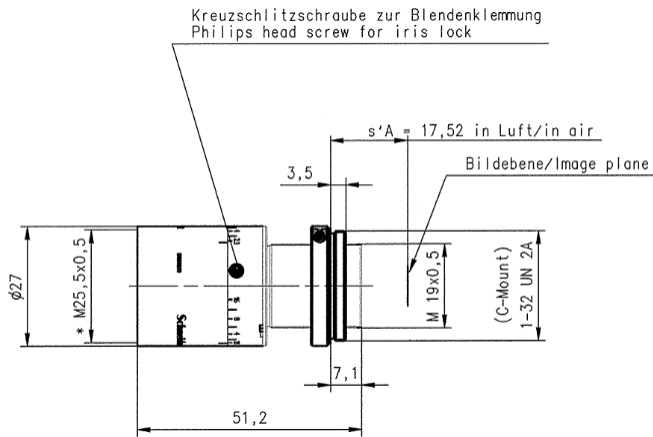

XR 2.3/35

f'	=	34.8 mm	β_p'	=	0.903
s_F	=	-11.0 mm	s_{EP}	=	27.6 mm
$s_{F'}$	=	22.0 mm	s_{AP}	=	-9.5 mm
HH'	=	-1.3 mm	Σd	=	35.3 mm

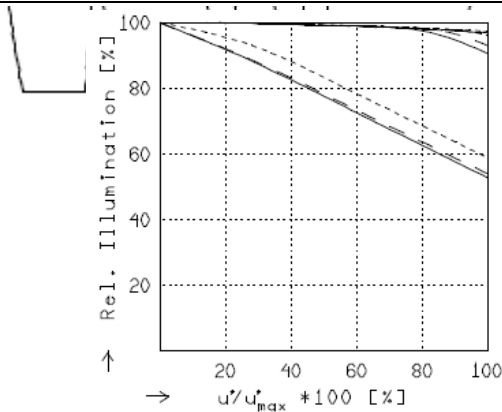

RELATIVE ILLUMINATION

The relative illumination is shown for the given focal distances or magnifications.

	$f / 2.4$	$f / 4.0$	$f / 5.6$
— $\beta' = -0.0200$	$u_{max}' = 4.5$	$00' = 1811.$	
- - $\beta' = -0.0500$	$u_{max}' = 4.5$	$00' = 767.$	
... $\beta' = -0.1000$	$u_{max}' = 4.5$	$00' = 420.$	

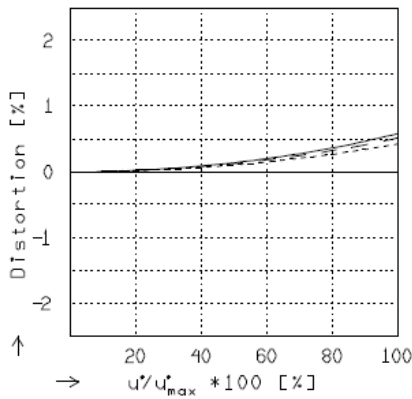

DISTORTION

Distortion is shown for the given focal distances or magnifications. Positive values indicate pincushion distortion and negative values barrel distortion.

— $\beta' = -0.0200$	$u_{max}' = 4.5$	$00' = 1811.$
- - $\beta' = -0.0500$	$u_{max}' = 4.5$	$00' = 767.$
... $\beta' = -0.1000$	$u_{max}' = 4.5$	$00' = 420.$

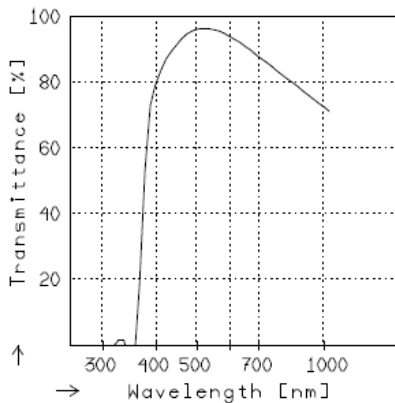

TRANSMITTANCE

Relative spectral transmittance is shown with reference to wavelength.

Xenon-RUBY 2.3/35

XR 2.3/35

MODULATION with reference to the relative image height

Wavelength λ	[nm]	555	655	605	505	455	405
Spectral weighting	[%]	19.8	23.7	22.2	15.7	12.1	6.7
Spatial frequency R	[1/mm]	20	40	80			
Format	[mm X mm]	0.0		9.0			
Diagonal $2u'$	[mm]	9.0					

radial —
tangential - -

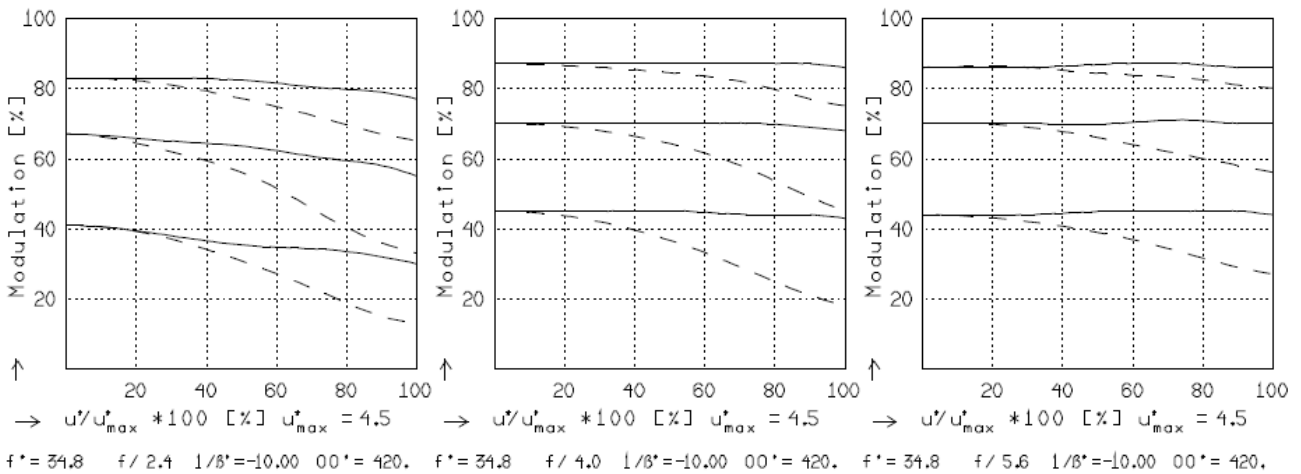
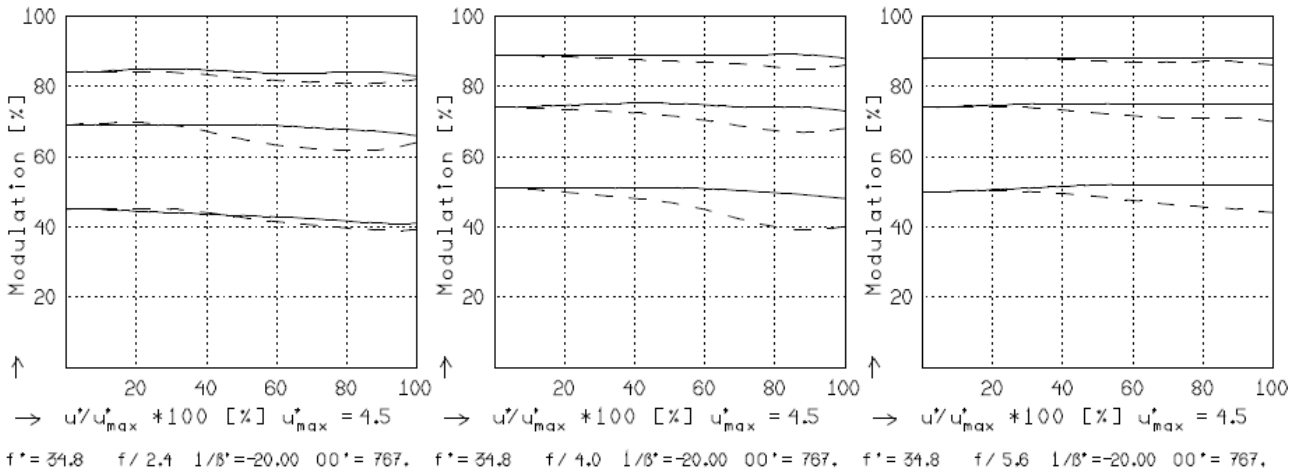
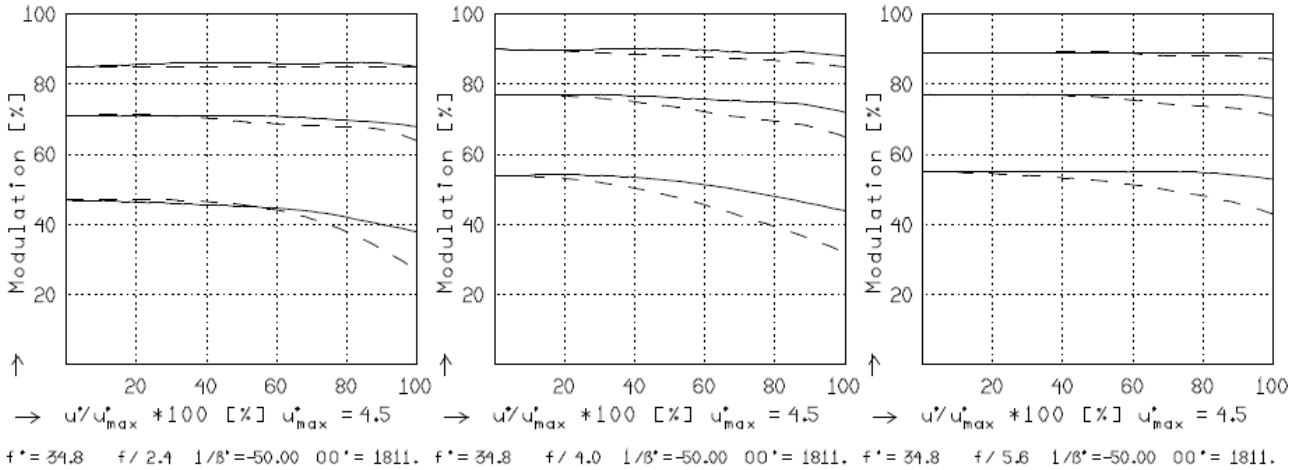

Focusing : MTF_{max} at $f / 2.3 \quad \ast \quad R = 80 \quad 1/mm, \quad u'/u'_{max} = 0$