



## SPECIAL FEATURES

- LCD Protection Glass
- Multi Source
- 5ms Response, 250 NITS, 800:1
- 3D Comb Filter / Deinterlace
- Built-In Speakers
- Video 2 In / 2 Out (BNC Type), HDMI 1 In, VGA 1 In, Audio 2 In (RCA Type), PC Stereo 1 In
- Touch Screen Optional
- Wall and Ceiling Mount

## SPECIFICATIONS

		19RTV
Display	Screen Size	19 Inch
	Max. Resolution	1280 x 1024 @ 75Hz
	Pixel Pitch	0.294 x 0.294mm
	Brightness	250cd/m <sup>2</sup>
	Contrast Ratio	800 : 1
	Aspect Ratio	4 : 3
	Viewing Angle (H/V)	160° / 160°
	Display Color	16.7 Million
	Response Time	< 5ms
	Video System	NTSC / PAL
Interface	Video In / Out (BNC Type)	2 / 2
	HDMI In	1
	VGA In (15Pin D-Sub)	1
	Audio In (RCA Type)	2 (L + R)
	PC Stereo In	1
Transmitter	Remote Control	Yes
Audio	Built-in Speakers	Yes (2W x 2)
	Filter Type	3D Comb Filter / Deinterlace
Features	LCD Protection Glass	Yes
	Auto Sleep Timer	Yes
	Composite time cycle	Yes
	Multi Language	English, French, German, Spanish, Italian, Dutch, Swedish, Finnish, Danish, Portuguese, Russian, Turkish, Japanese, Korean
Dimension	Outline Dimension (w/o stand)	16.5" x 14.0" x 2.44"
	Outline Dimension (w/ stand)	16.5" x 16.0" x 8.4"
	Net. Weight	5.4Kg (11.9lbs)
Cabinet	Color	Black
	Base Stand	Yes
	Tilt Function	Yes
Warranty	Part/Labor	2year / 2year
	MTBF (Approx.)	50,000 Hours
Regulations		RoHS, UL, CB, FCC (A), CE-Emc (LVD)
Power	Consumption: < On	< 45W
	Electrical Ratings	AC100 ~ 240V(50/60Hz) DC12V / 3.8A
Circumstance	Operating Temperature	0 ~ 50°C / 32 ~ 122°F
	Storage Temperature	-20 ~ 60°C / -4 ~ 140°F
Mounts	VESA™ Mount Size	100 x 100mm (BS M4 x 10mm Screw)
	Wall	WB-5, WB-10, WB-30, WB-31
	Ceiling	CMK-01
	Rack	RMK-08

\*Design and specifications are subject to change without notice

## DIMENSIONS

19RTV

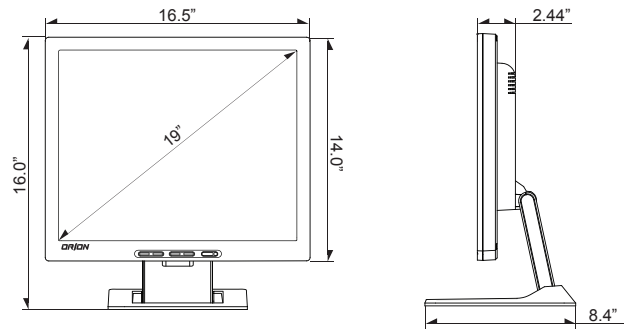

## TILT FUNCTION

